

HL616H/1

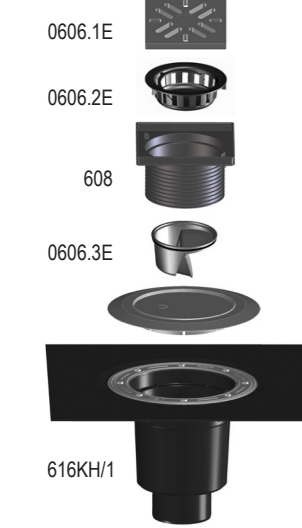

5,50 l/s
DN110

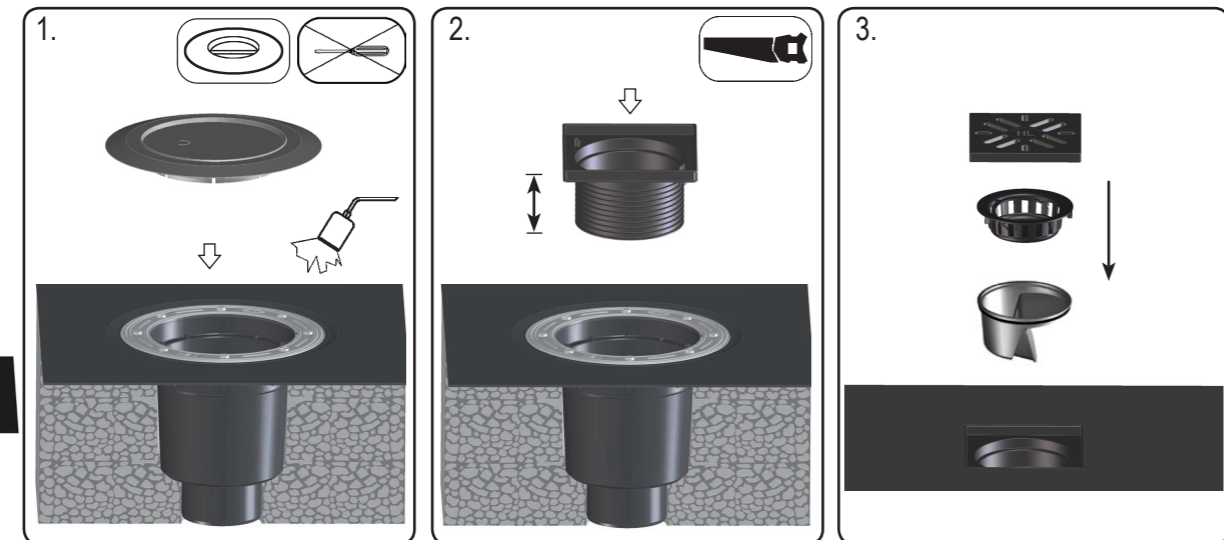

D Großablauf **TR** BÜYÜK ÇAPLI SÜZGEÇ
I GRANDO SCARICO **CZ/SK** VELKOKAPACITNÍ ODTOK
GB MAJOR DRAIN **HR** VELIK SLIVNIK

H NAGYLEFOLYÓ **RO** RECEPTOARE MARI
PL WPUST PODWÓRZOWY **PYC** Дворовый трап
SLO VELIKI ODTOK **BUL** Голям сифон

80.08.2017

HL616H/1

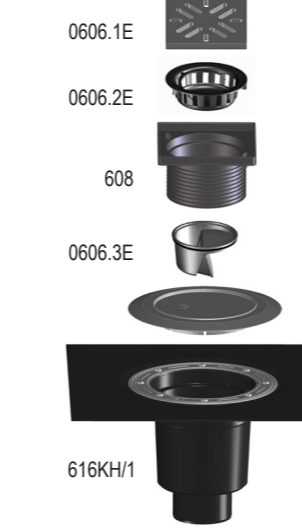

5,50 l/s
DN110

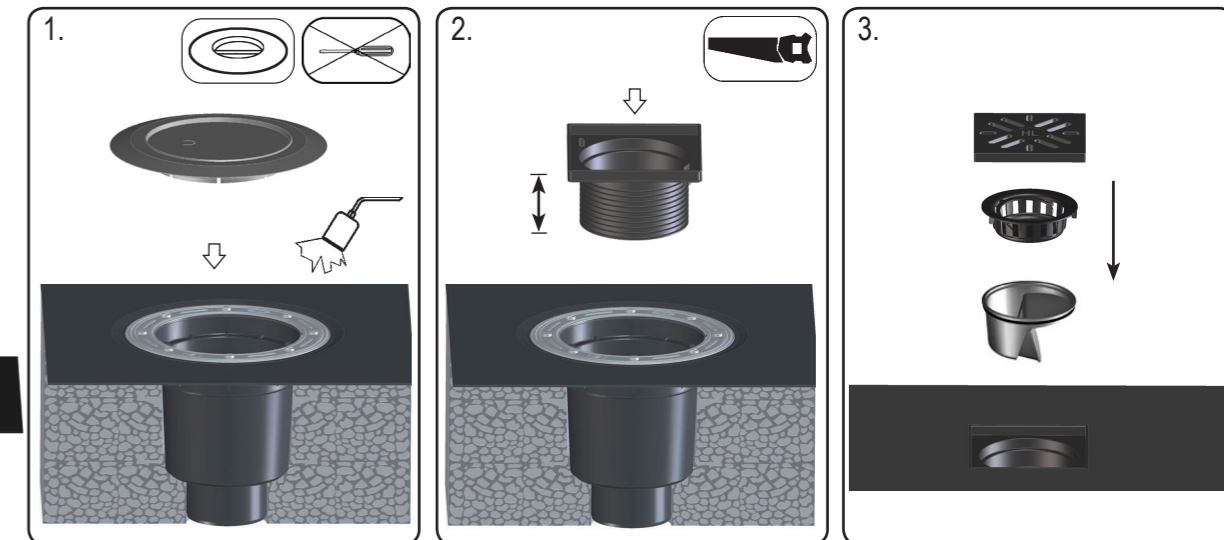

D Großablauf **TR** BÜYÜK ÇAPLI SÜZGEÇ
I GRANDO SCARICO **CZ/SK** VELKOKAPACITNÍ ODTOK
GB MAJOR DRAIN **HR** VELIK SLIVNIK

H NAGYLEFOLYÓ **RO** RECEPTOARE MARI
PL WPUST PODWÓRZOWY **PYC** Дворовый трап
SLO VELIKI ODTOK **BUL** Голям сифон

80.08.2017

HL616H/1

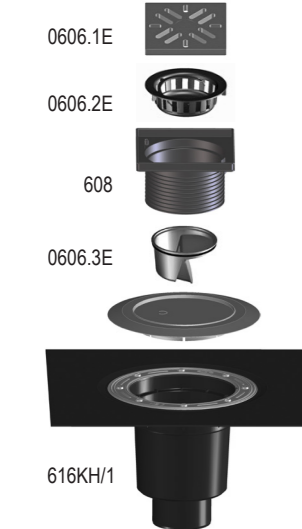

5,50 l/s
DN110

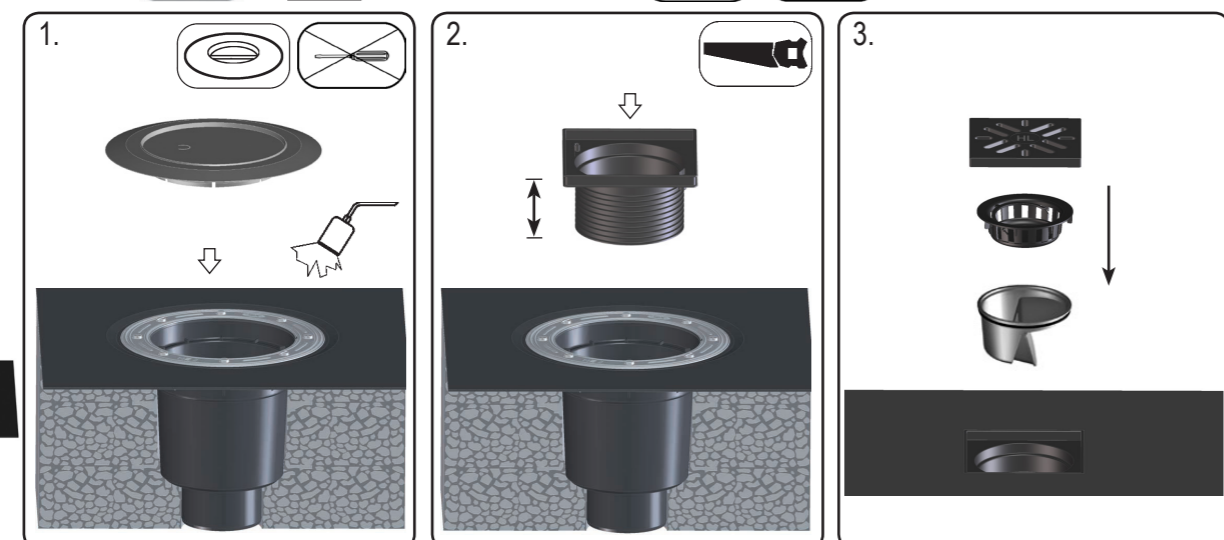

D Großablauf **TR** BÜYÜK ÇAPLI SÜZGEÇ
I GRANDO SCARICO **CZ/SK** VELKOKAPACITNÍ ODTOK
GB MAJOR DRAIN **HR** VELIK SLIVNIK

H NAGYLEFOLYÓ **RO** RECEPTOARE MARI
PL WPUST PODWÓRZOWY **PYC** Дворовый трап
SLO VELIKI ODTOK **BUL** Голям сифон

80.08.2017

HL616H/1

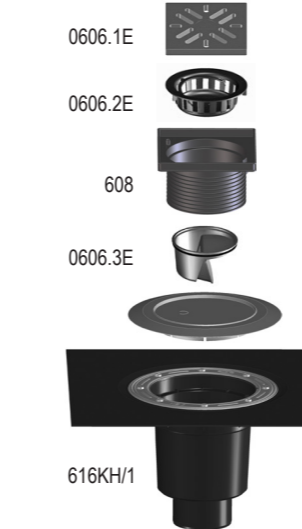

5,50 l/s
DN110

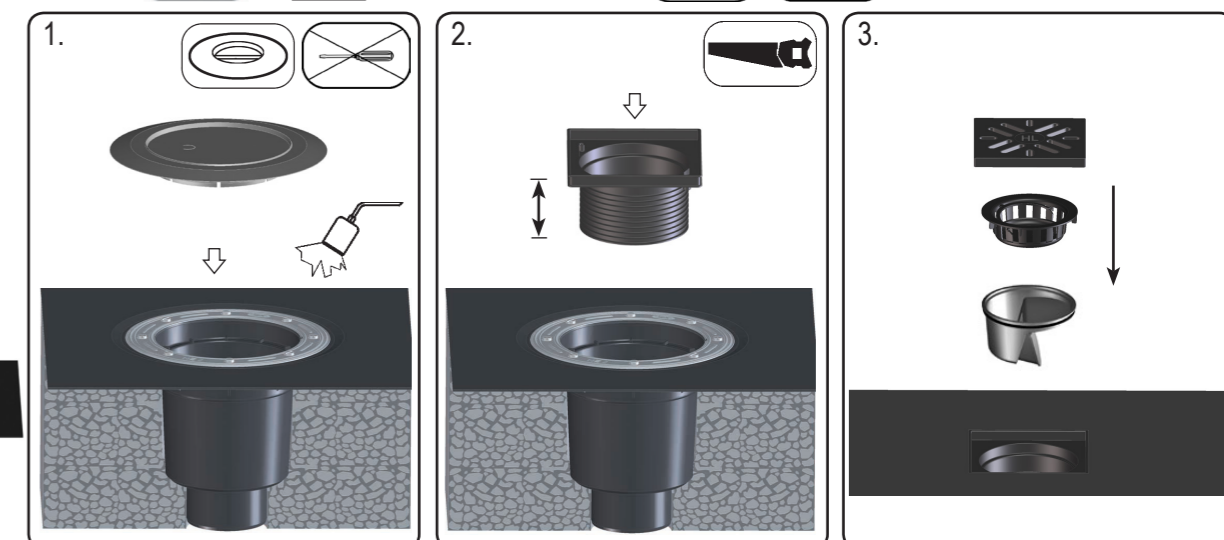

D Großablauf **TR** BÜYÜK ÇAPLI SÜZGEÇ
I GRANDO SCARICO **CZ/SK** VELKOKAPACITNÍ ODTOK
GB MAJOR DRAIN **HR** VELIK SLIVNIK

H NAGYLEFOLYÓ **RO** RECEPTOARE MARI
PL WPUST PODWÓRZOWY **PYC** Дворовый трап
SLO VELIKI ODTOK **BUL** Голям сифон

80.08.2017