

HL616.1/5

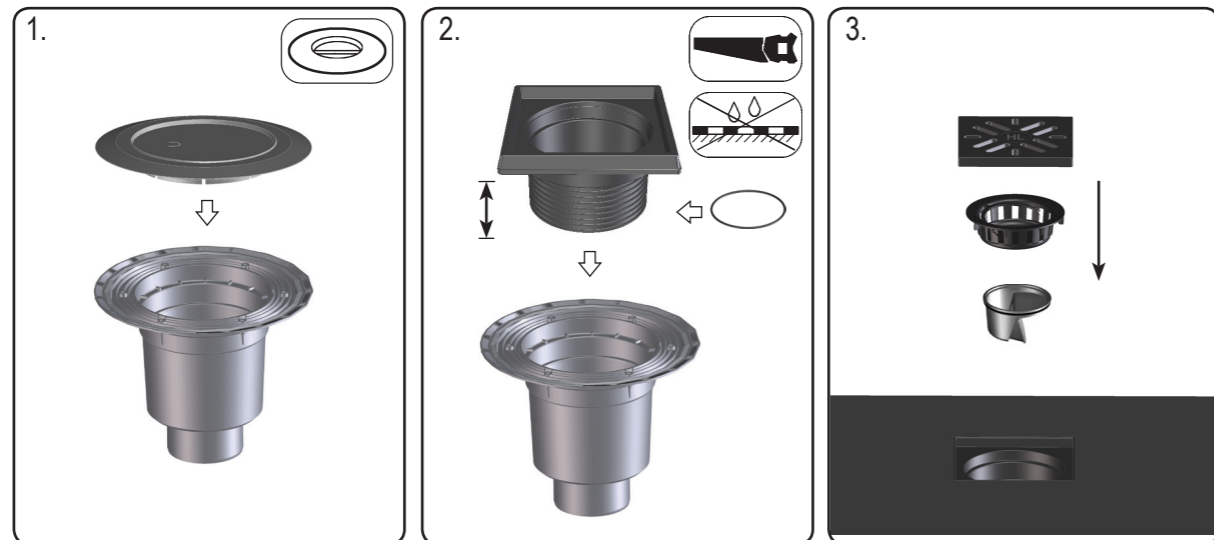

4,8 l/s
DN160

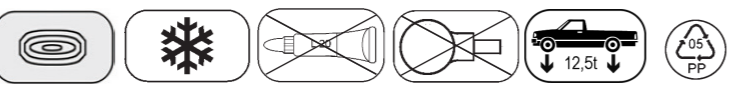

D Großablauf **TR** BÜYÜK ÇAPLI SÜZGEÇ
I GRANDO SCARICO **CZ/SK** VELKOKAPACITNÍ ODTOK
GB MAJOR DRAIN **HR** VELIK SLIVNIK
H NAGYLEFOLYÓ **RO** RECEPTOARE MARI
PL WPUST PODWÓRZOWY **PYC** Дворовый трап
SLO VELIKI ODTOK **BUL** Голям сифон

04.07.2012

HL616.1/5



4,8 l/s
DN160

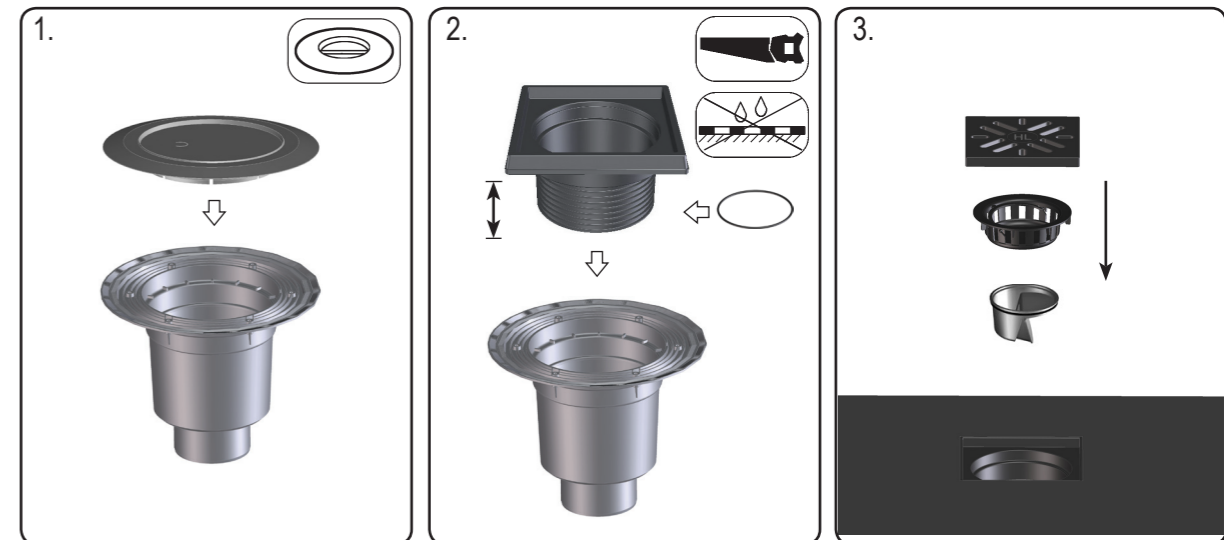
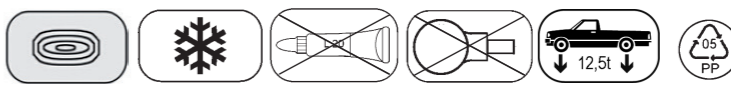

D Großablauf **TR** BÜYÜK ÇAPLI SÜZGEÇ
I GRANDO SCARICO **CZ/SK** VELKOKAPACITNÍ ODTOK
GB MAJOR DRAIN **HR** VELIK SLIVNIK
H NAGYLEFOLYÓ **RO** RECEPTOARE MARI
PL WPUST PODWÓRZOWY **PYC** Дворовый трап
SLO VELIKI ODTOK **BUL** Голям сифон

04.07.2012

HL616.1/5



4,8 l/s
DN160

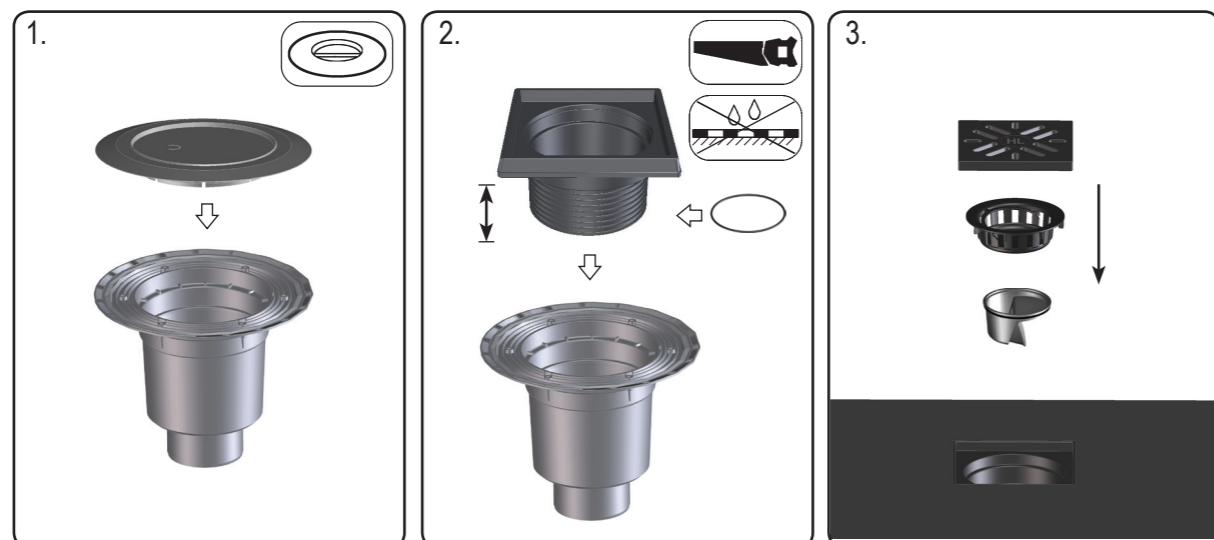
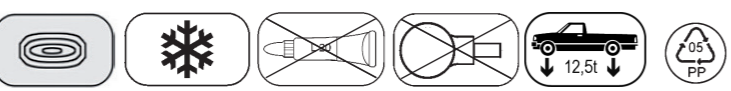

D Großablauf **TR** BÜYÜK ÇAPLI SÜZGEÇ
I GRANDO SCARICO **CZ/SK** VELKOKAPACITNÍ ODTOK
GB MAJOR DRAIN **HR** VELIK SLIVNIK
H NAGYLEFOLYÓ **RO** RECEPTOARE MARI
PL WPUST PODWÓRZOWY **PYC** Дворовый трап
SLO VELIKI ODTOK **BUL** Голям сифон

04.07.2012

HL616.1/5



4,8 l/s
DN160

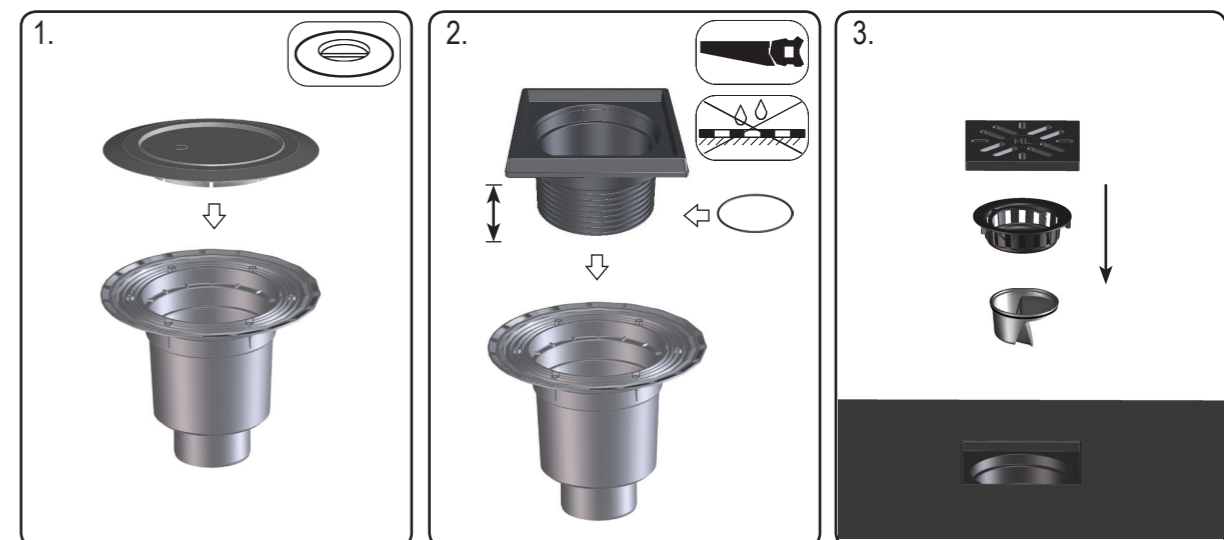
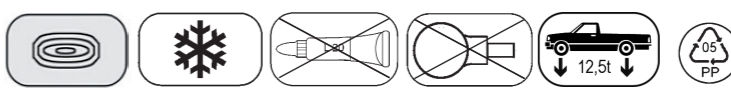

D Großablauf **TR** BÜYÜK ÇAPLI SÜZGEÇ
I GRANDO SCARICO **CZ/SK** VELKOKAPACITNÍ ODTOK
GB MAJOR DRAIN **HR** VELIK SLIVNIK
H NAGYLEFOLYÓ **RO** RECEPTOARE MARI
PL WPUST PODWÓRZOWY **PYC** Дворовый трап
SLO VELIKI ODTOK **BUL** Голям сифон

04.07.2012