

Schnitt A-A

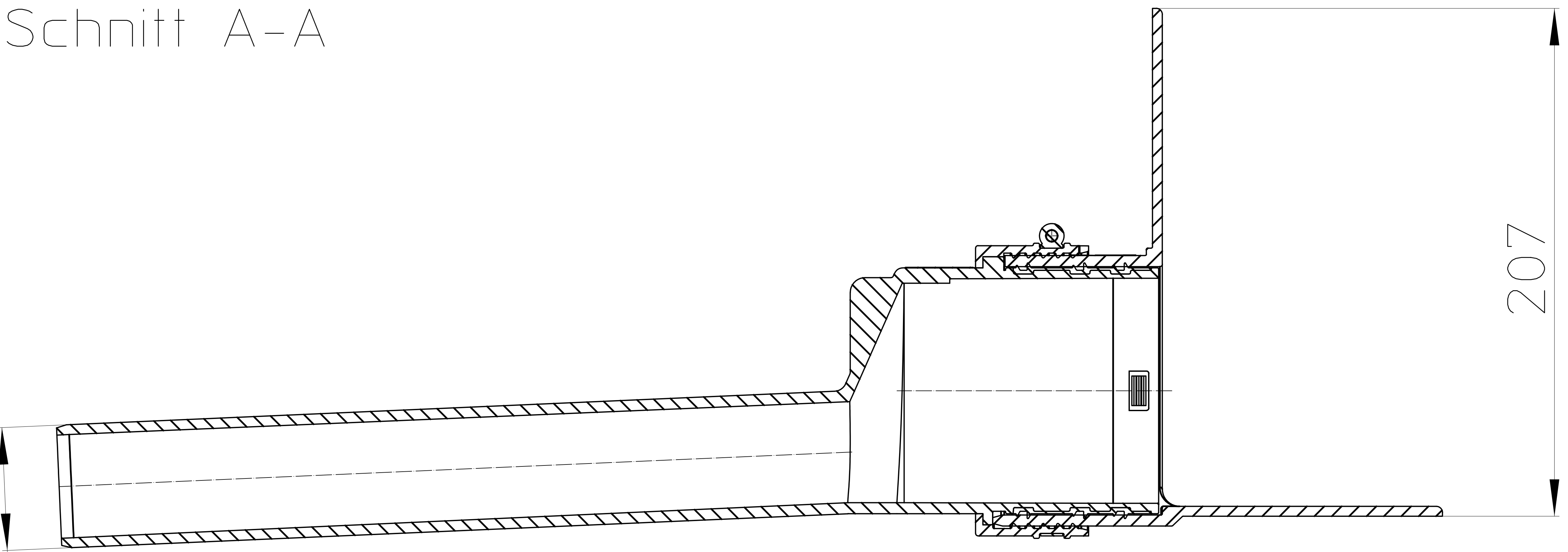

DN50

207

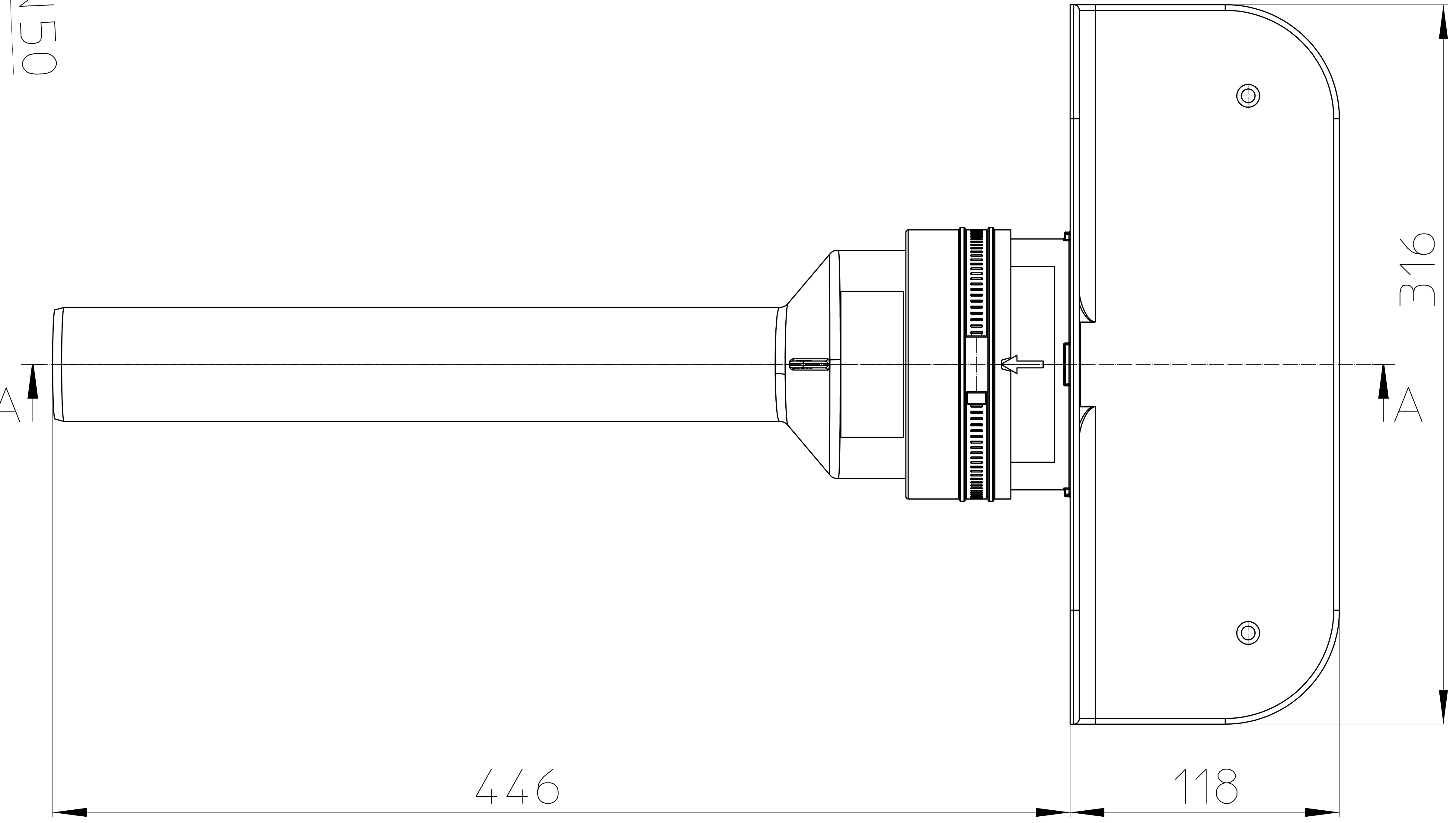

A

A

446

316

118