

HL310Prblue-3120 < 0,50 l/sec DN 50/75/110

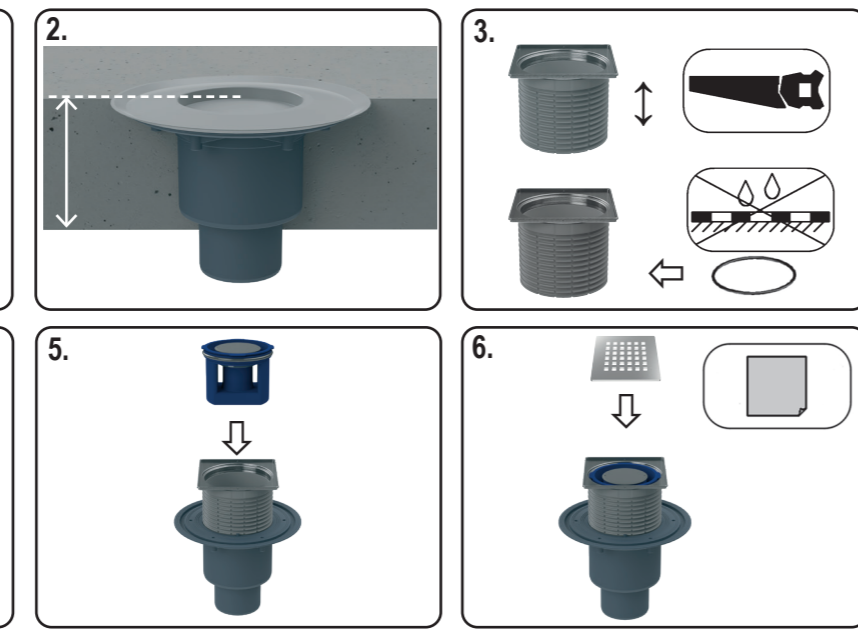
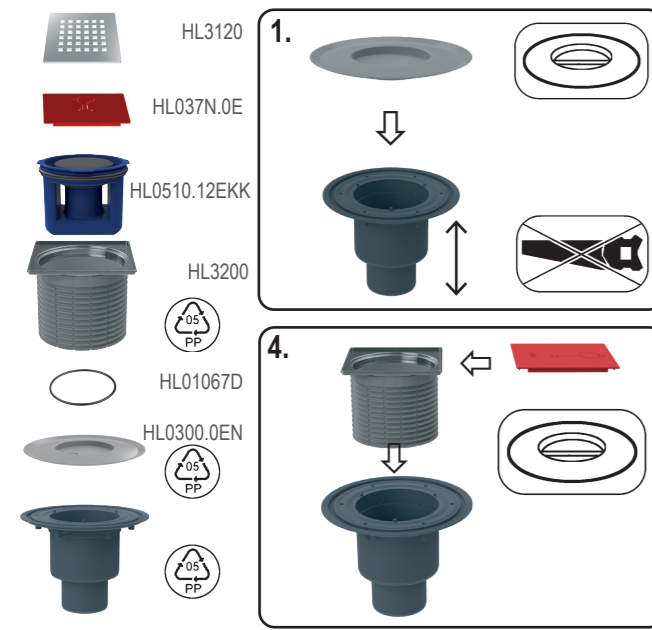
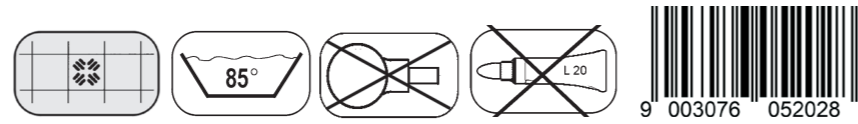

D BODENABLAUF
IT SCARICO A PAVIMENTO
GB FLOOR DRAIN

TR YER SÜZGEÇİ
CZ/SK PODLAHOVÁ VPUST
HR PODNI ODVOD

HU PADLÓLEFOLYÓ
PL WPUST PODŁOGOWY
SI TALNI ODTOK

RO SIFON DE PARDOSEALĂ
RU ТРАП
BG ПОДОВ СИФОН

27.02.2024

HL310Prblue-3120 < 0,50 l/sec DN 50/75/110

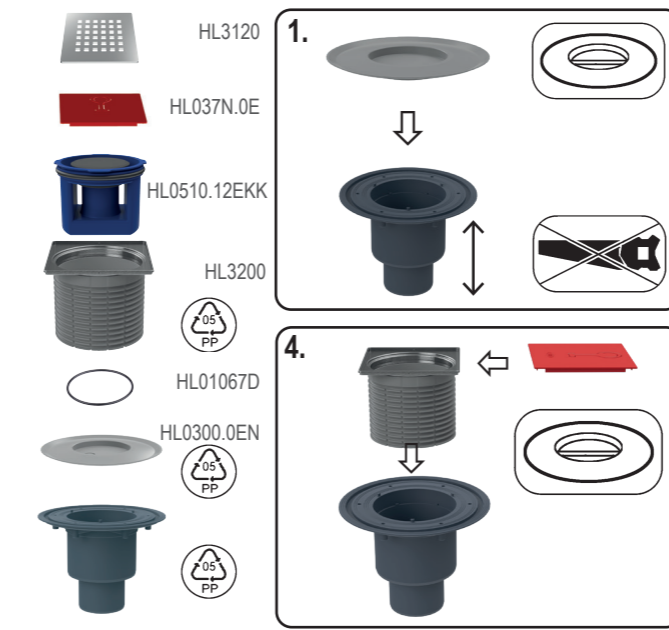
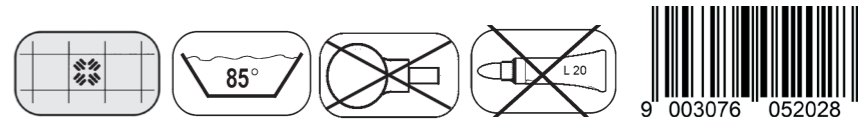

D BODENABLAUF
IT SCARICO A PAVIMENTO
GB FLOOR DRAIN

TR YER SÜZGEÇİ
CZ/SK PODLAHOVÁ VPUST
HR PODNI ODVOD

HU PADLÓLEFOLYÓ
PL WPUST PODŁOGOWY
SI TALNI ODTOK

RO SIFON DE PARDOSEALĂ
RU ТРАП
BG ПОДОВ СИФОН

27.02.2024

HL310Prblue-3120 < 0,50 l/sec DN 50/75/110

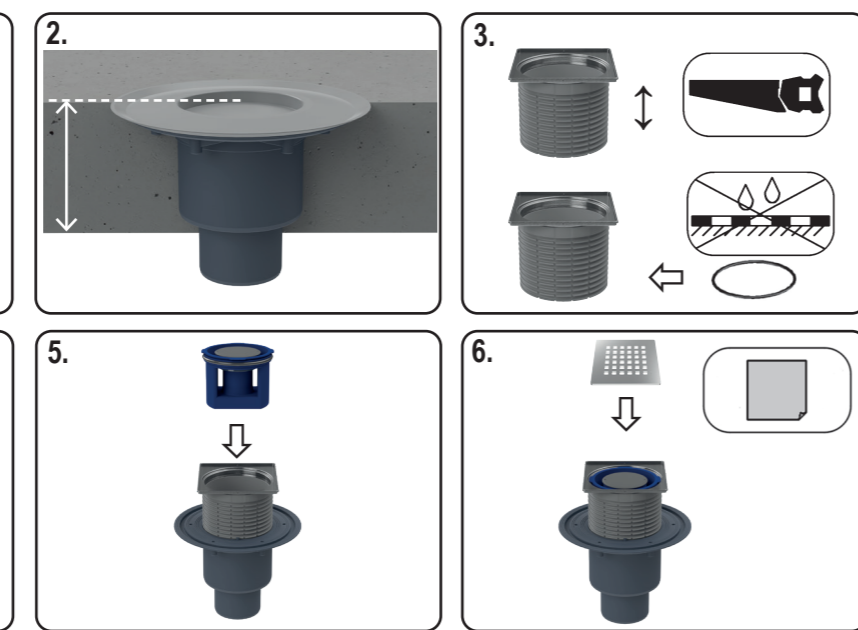
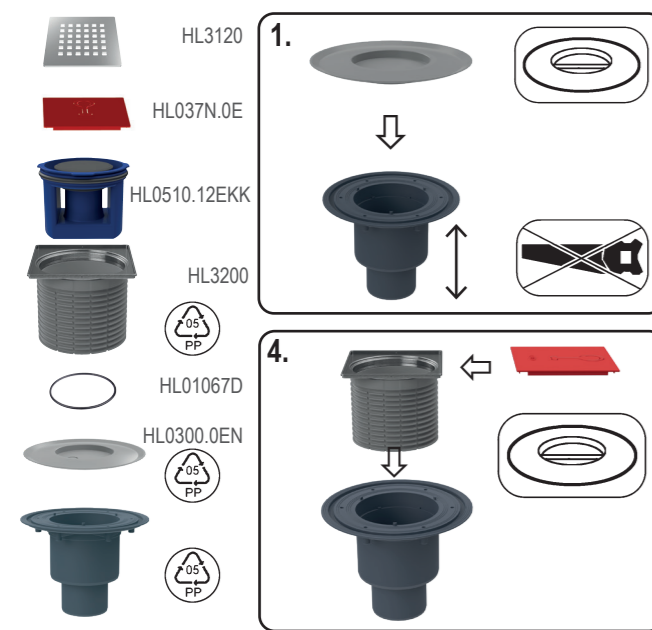
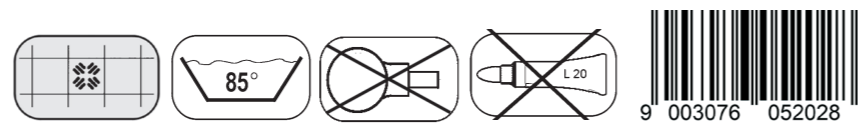

D BODENABLAUF
IT SCARICO A PAVIMENTO
GB FLOOR DRAIN

TR YER SÜZGEÇİ
CZ/SK PODLAHOVÁ VPUST
HR PODNI ODVOD

HU PADLÓLEFOLYÓ
PL WPUST PODŁOGOWY
SI TALNI ODTOK

RO SIFON DE PARDOSEALĂ
RU ТРАП
BG ПОДОВ СИФОН

27.02.2024

HL310Prblue-3120 < 0,50 l/sec DN 50/75/110

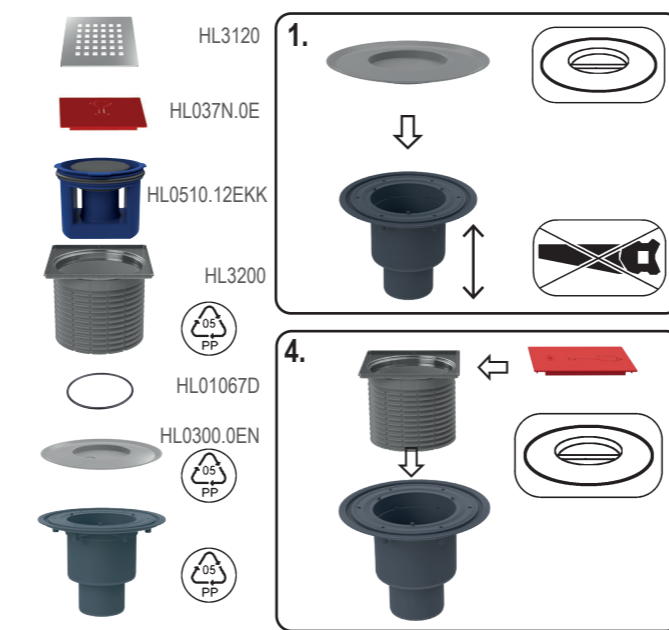
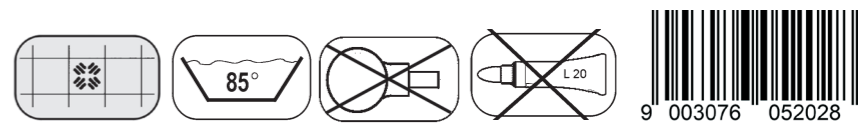

D BODENABLAUF
IT SCARICO A PAVIMENTO
GB FLOOR DRAIN

TR YER SÜZGEÇİ
CZ/SK PODLAHOVÁ VPUST
HR PODNI ODVOD

HU PADLÓLEFOLYÓ
PL WPUST PODŁOGOWY
SI TALNI ODTOK

RO SIFON DE PARDOSEALĂ
RU ТРАП
BG ПОДОВ СИФОН

27.02.2024